

# SPECIFICATIONS

HELICAL ANTENNA

AF 816M157502-T

TAIYO YUDEN CO., LTD.

Date : 18.Sep.2007

# HELICAL ANTENNA

## Table of Contents

1.0 Scope

2.0 Environment condition

3.0 Electrical specifications

4.0 Mechanical specifications

5.0 Reliability test

6.0 Packing specification

7.0 Precautions

### ※RoHS compliance

- This product conform to "RoHS compliance".
- "RoHS compliance" means that the product does not contain lead, cadmium, mercury, hexavalent chromium, PBB or PBDE referring to EU Directive 2002/95/EC, except other non-restricted substances or impurities which could not be technically removed at the refining process.

## 1.0 Scope

This specification covers the helical antenna in mounted condition on Taiyo Yuden evaluation board.

### Part Numbering System

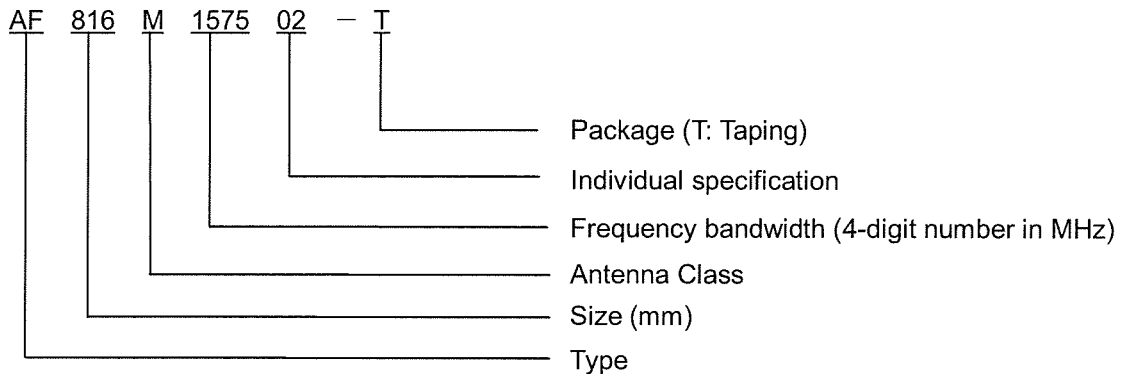

## 2.0 Environment condition (Refer to the reliability test of table -1 for the reliability assurance)

- 2.1 Operating temperature range : -20°C to +80°C
- 2.2 Humidity : 15 to 95%RH (Without dew condensation)
- 2.3 Storage temperature range (Antenna of single unit)  
: -40°C to +85°C
- 2.4 Storage temperature and humidity range (packing condition)  
: -10°C to +40°C, 15 to 85% RH

## 3.0 Electrical characteristics

- 3.1 Input Impedance : 50Ω (Specified value )
- 3.2 Frequency bandwidth : 1574.397 to 1576.443MHz
- 3.3 Gain\*<sup>1</sup>  
: 0 dBi min. (Peak)  
: -3 dBi min.  
(Vertical polarization average gain of omni directional plane)  
: -7 dBi min. (Total average gain)
- 3.4 VSWR in bandwidth\*<sup>2</sup> : 3.0 (Typical)

\* 1: Total average gain in 3.3 of electrical characteristics shall be total average gain of V, H polarization in X-Y, Y-Z and X-Z side (Average of total measurement points) in mounted on Taiyo Yuden evaluation board.

\* 2: VSWR in bandwidth in 3.4 of electrical specification shall be VSWR mounted on Taiyo Yuden on standard board.

## 4.0 Mechanical performance

- 4.1 Shape dimension: Refer to figure -1.
- 4.2 Dimension of evaluation board and land-patterns: Refer to figure -2, 3.

## 5.0 Reliability test

Reliability test : To satisfy a reliability test per table -1.

## 6.0 packing specification

Packing form : Refer to pages 9 to 11.

## 7.0 Precautions

Refer to precautions in page 8.

Table 1

## Reliability test

No.	Test Item	Test method	Judgment method *3
1	Humidity Test	Electrical characteristic is evaluated after products are left in 60°C and 90% to 95%RH for 96 hours, and then in normal temperature and humidity for 1 hour.	To Satisfy less than 3.0 VSWR in bandwidth.
2	High Temperature Test	Electrical characteristic is evaluated after products are left in the atmosphere of 85°C for 96 hours, and left in normal temperature for 1 hour.	To Satisfy less than 3.0 VSWR in bandwidth.
3	Low Temperature Test	Electrical characteristic is evaluated after products are left in the atmosphere of -40°C for 96 hours, and left in normal temperature for 1 hour.	To Satisfy less than 3.0 VSWR in bandwidth.
4	Thermal Shock	Electrical characteristic is evaluated after products exposed alternately in -40°C and 85°C for every 30minutes for each temperature 10 times, and are left for 1 hour in normal temperature.	To Satisfy less than 3.0 VSWR in bandwidth.
5	Solderability	Products shall be submerged in solder (HS63S) of 230±5°C for 3±1 seconds after products are preheated in PO-Z-7 flux of 150°C. Then these products are picked up and appearance is checked by magnifier of 10 times.	At least 90% of terminal electrode is covered with new solder.
6	Soldering Heat Resistance (Reflow)	An electrical character is evaluated after products is subjected by 2 times reflow by temperature pattern as shown in next page.	To Satisfy less than 3.0 VSWR in bandwidth.

\* 3 : Chip antenna on our company standard circuit board is tuned less than 3.0 VSWR in bandwidth and VSWR in bandwidth is measured after the reliability test.

Reflow soldering temperature profile

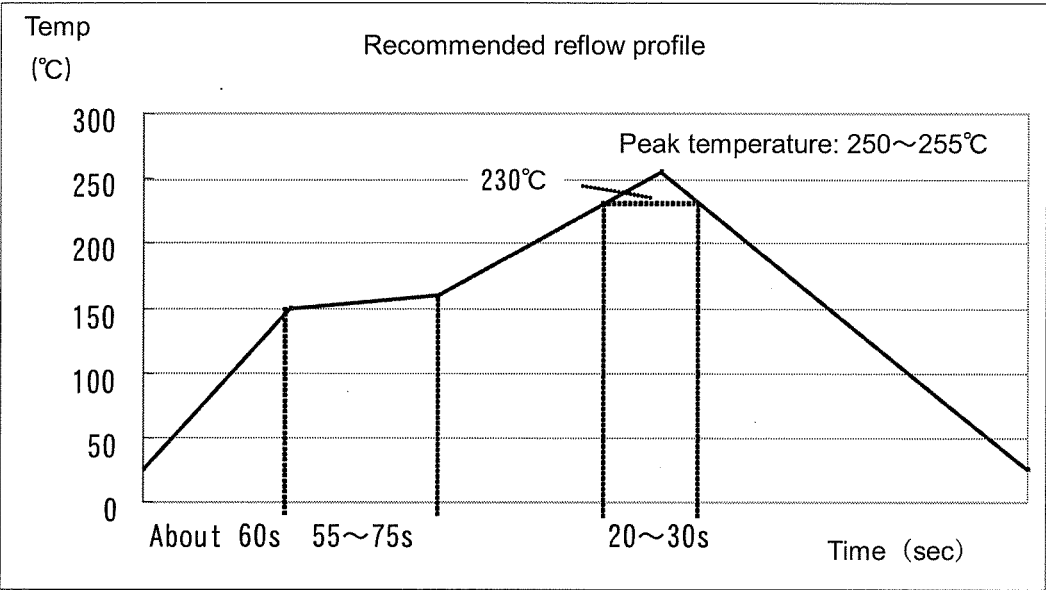
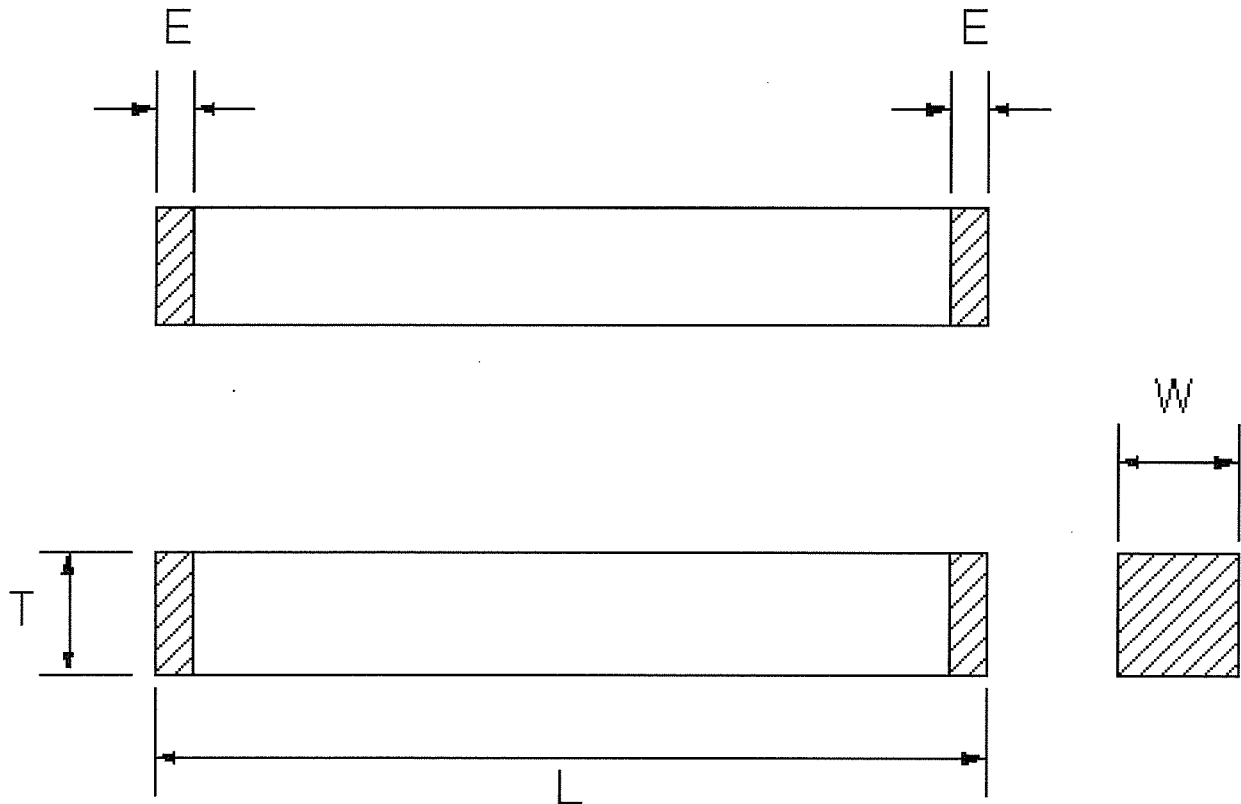

Figure -1

Part number: AF\_816M157502-T

Shape dimension



Code	L	W	T	E
Size	$8.0 \pm 0.2$	$1.6 \pm 0.2$	$1.6 \pm 0.2$	$0.5 \pm 0.3$

Unit : mm

Figure -2  
Dimension of evaluation board for this antenna

- Board material: FR-4
- Thickness of base material: 0.8mm
- Electrode pattern: single-side
- Thickness of electrode:  $35 \mu\text{m}$
- Land part: Refer to figure-3

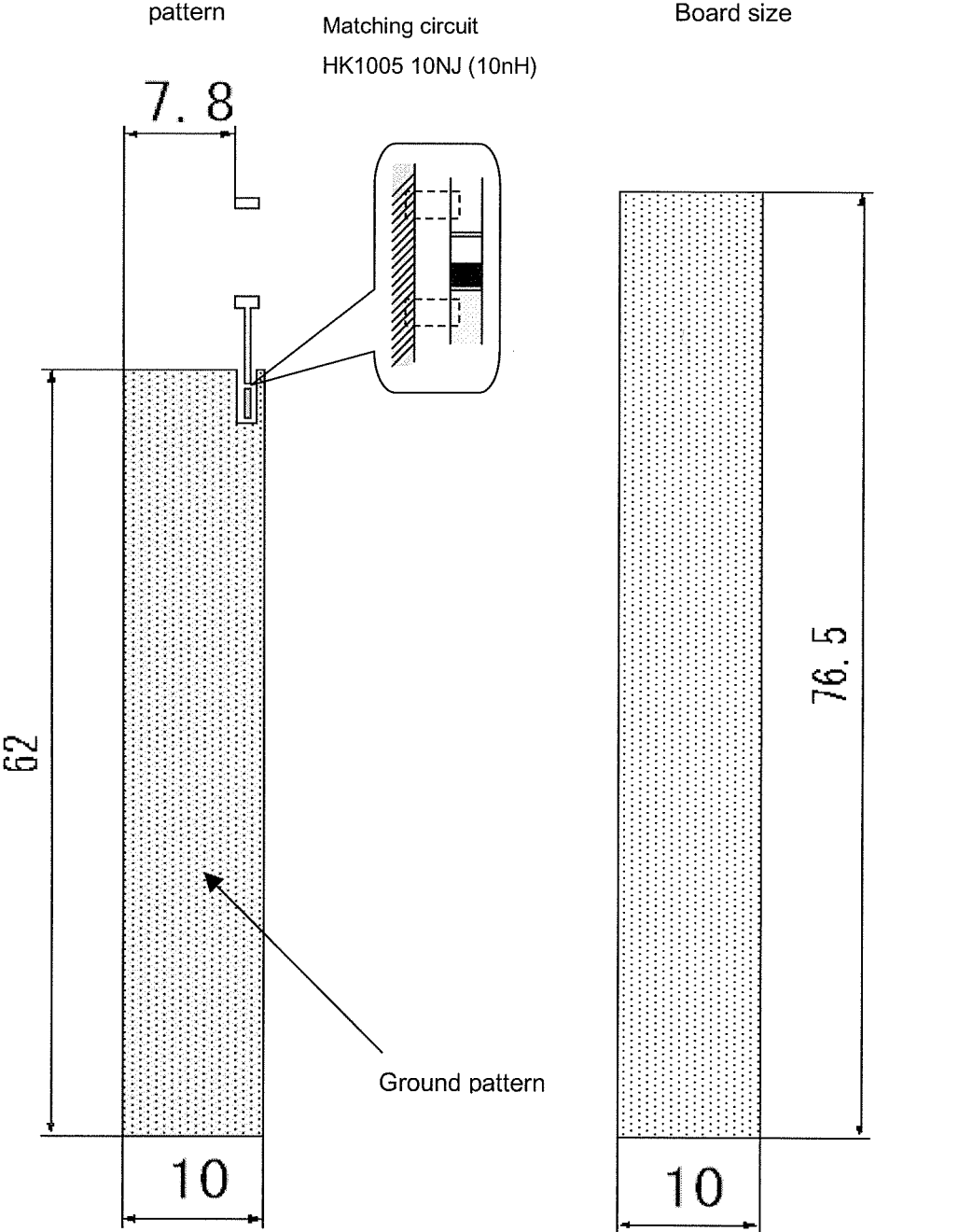

Unit : mm

Figure -3

Antenna land-patterns

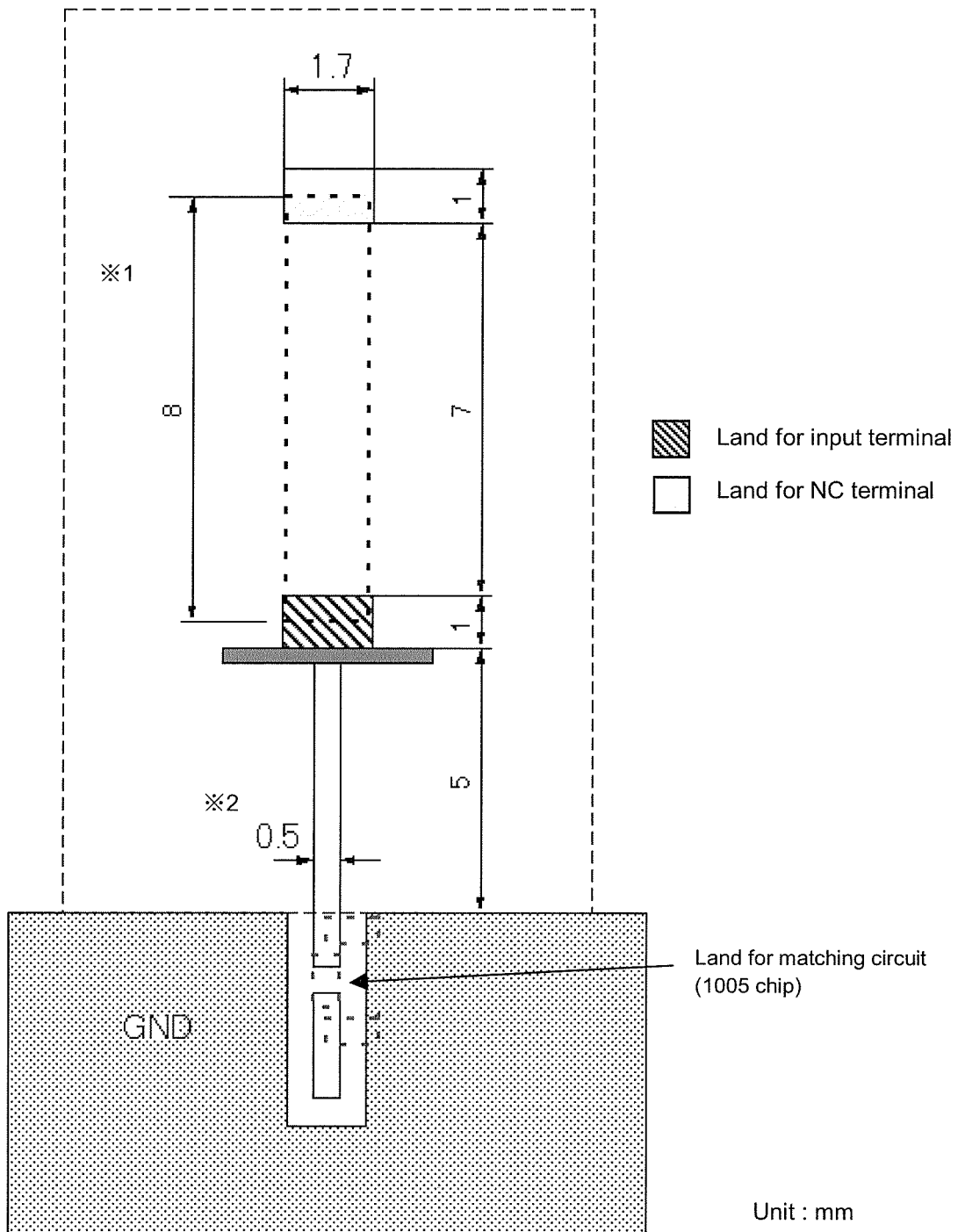

※1 : Please don't arrange the surface and inside layer pattern near the antenna mounting area.  
(Refer to our company evaluation circuit board.)

※2 : A solder area is set at solder resist.



## Precautions

1. Be careful of using these products because characteristics may be deteriorated when it is used in the following environment.
  - Special gas atmosphere (Such as Cl<sub>2</sub>, NH<sub>3</sub>, SO<sub>x</sub> and No<sub>x</sub>, etc.)
  - Gas atmosphere with volatility and flammability
  - Place where dust is abundant
  - Place where water splashes directly, dew condensation is ease to occur because of high humidity, direct sunlight is subjected and freeze.
2. Don't apply excessive pressure and shock because these products are made from ceramics element.
3. Don't apply excessive pressure and shock to these products during transporting and handling of print circuit board that these products are soldered.
4. Be careful of handling (Don't fall and hit) because characteristics changes when electrode is damaged and chipped out. And, don't touch these products with bare hands because it causes a solderability decline.
5. Please storage under the following condition
  - Temperature : Below +40 °C
  - Humidity : Below 85% RHUse these products after the delivery within six months. And, after more than six months have passed, confirm solderability before the use them.
6. Arrange these products of position of mounting where stress isn't applied against sled and deflection of circuit board.

Be careful not to apply stress and deflection of board during process after soldering these products (circuit board cut, break board checker, mounting of other components, installation to chassis and wave soldering to backside of the circuit board after Reflow soldering) because electrode peeling and chip break occur by stress and deflection. When separating print circuit board after mounting, please 7. Be careful not to apply excessive stress and shock to prevent break and chip out during mounting these products on print circuit board.
8. Please use flux containing less than 0.1% wt (cl conversion) of halogen material in soldering to prevent corrosion of electrodes and decline of insulation resistance.
9. Preheat in soldering so as to be less than 100°C between solder temperature and products temperate to prevent break of these products.
10. When supersonic washing is applied, please confirm cleaning condition in advance because crack may occur in these products and the soldering part by vibration and strength of the terminal electrode may be declined.
11. When repairing by hand solder iron, temperature of soldering iron should be less than less than 320°C for less than 3 seconds to prevent a terminal electrode decline.
12. Reduce mechanical vibration or shock as much as possible, and do not drop the product.

## Tape Packaging (T)

◎In case of taping packing, plastic tapes shall be used.

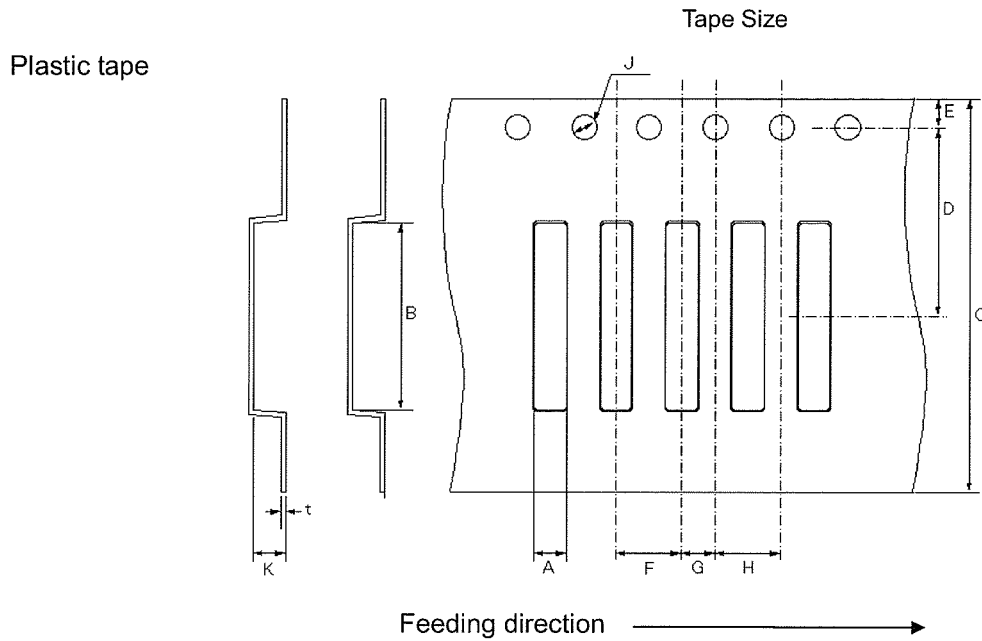

### Dimensions

Code	A※	B※	C	D	E	F	G
Size	1.95±0.1	8.4±0.1	16.0±0.2	7.5±0.1	1.75±0.1	4.0±0.1	2.0±0.1

[Unit : mm]

### Dimensions

Code	H	J	K	t※
Size	4.0±0.1	$\phi 1.5 \begin{matrix} +0.1 \\ -0 \end{matrix}$	1.95±0.1	0.30±0.05

※A, B, t : Sufficient clearance.

[Unit : mm]

### Dimension of Reel

Code	A	B	C
Size	$\phi 178 \pm 2.0$	$\phi 50 \text{ min.}$	$\phi 13.0 \pm 0.2$

Code	D	E	W
Size	$\phi 21.0 \pm 0.8$	2.0±0.5	17.0±1.0

Code	t	R
Size	2.5 max.	1.0

[Unit : mm]

### Dimensions of Reel

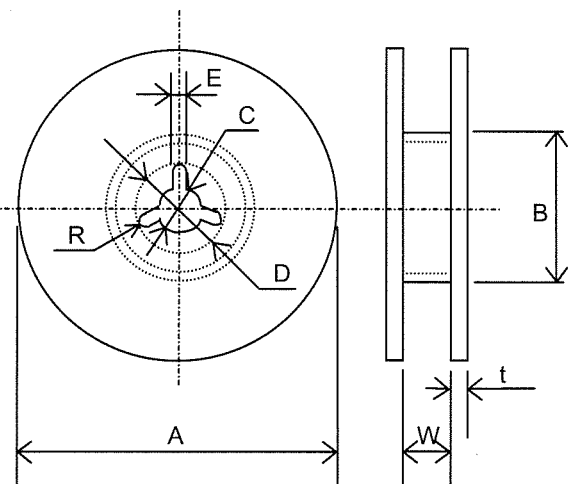

## Tape Packaging (T)

1. Taping shall be right-sided wound. When the end is pulled out, sprocket hole will be at the right-hand side.
2. For packaging chips by taping, blank spaces are provided on taping as shown in the figure.
  - Leader part 400mm min.
  - Leader part (Blank part) 20 pockets min.
  - Trailer (Blank part) 40 pockets min.

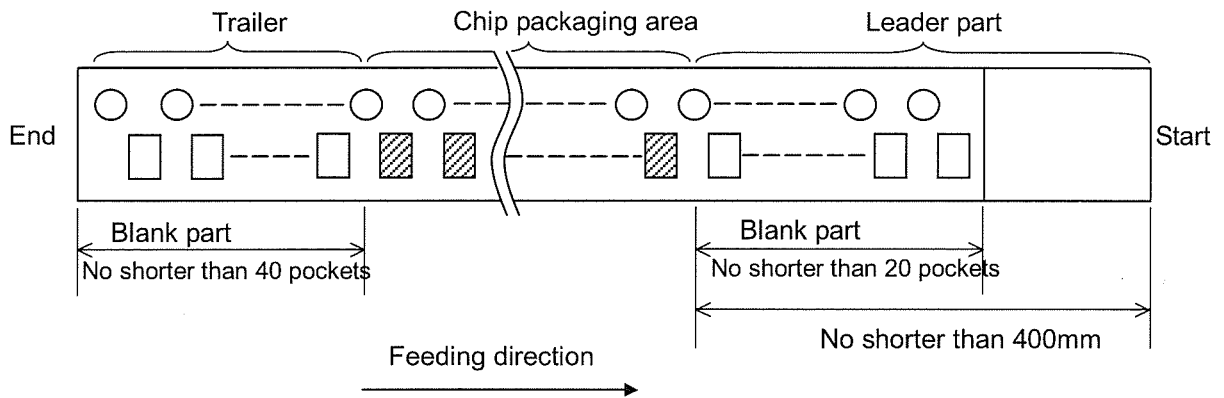

3. Seal tape of plastic taping shall not be crossed over sprocket holes.
4. Plastic tape shall not be seamed.
5. Tensile strength of tape is 5N (0.51kgf) or over.
6. Number of chips missed from tape reel shall be 1 piece maximum per reel.
7. Standard number of chips contained in a reel shall be 2,000 pieces.
8. Label indicating part No., quantity and control No. shall be attached to the outside of reel.
9. Peeling strength of seal tape (or top tape) shall be 0.1~0.7N (10.2~71.4gf) when seal tape (or top tape) is peeled from carrier tape at an angle of  $0^{\circ} \sim 20^{\circ}$ .

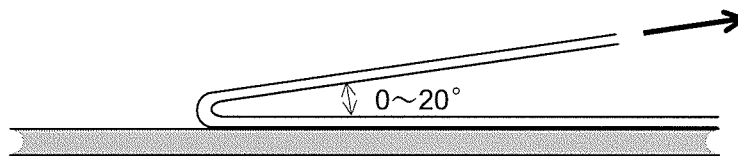

Tape Packaging (T)

[Packaging Mode]

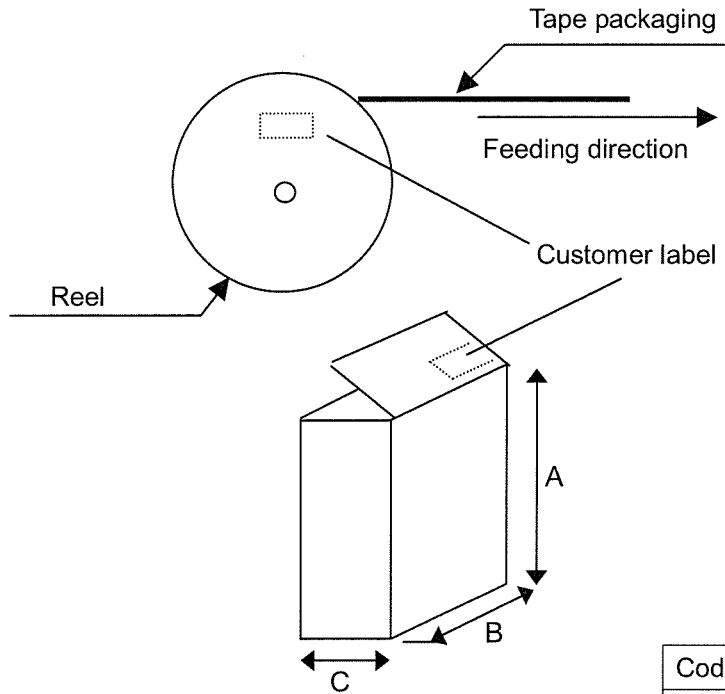

Customer label description

1. Manufacturer Name
2. Customer Parts No.
3. Our Parts No.
4. Quantity
5. Control No.  
(Shipping Lot No.)
6. Manufacturing site  
(MADE IN ○○○)

Code	A	B	C	Reel
Size	190	185	70	3 reels max.
			140	6 reels max.

[Unit: mm] (The size is only for reference.)

Material: Paper

Packaging unit: Maximum 3 reels or 6 reels in a box.

- To attach labels means that all products are passed.

## Composition of the shipping lot number

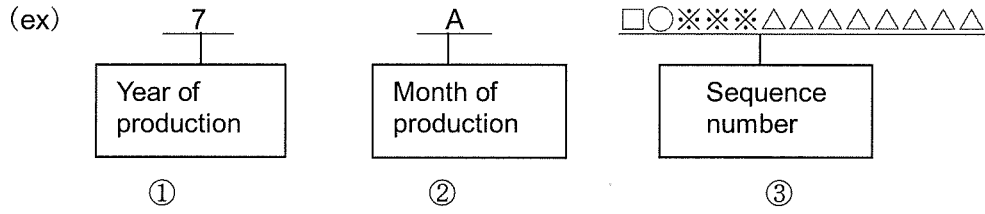

- ①Year of production (The last numeral of the Christian era. 2007year → 7)
- ②Month of production (It is due to the table below.)
- ③Sequence number is alphanumeric including space.

month	1	2	3	4	5	6	7	8	9	10	11	12
code	A	B	C	D	E	F	G	H	J	K	L	M

Operating conditions for guarantee of this product are as shown in the specification.

Please note that Taiyo Yuden Co., Ltd. shall not be responsible for a failure and/or abnormality which are caused by use under the conditions other than the aforesaid operating conditions.

This product is developed, designed and intended for use in general electronics equipments. (for AV, household, office supply, information service, telecommunications, etc.). Before incorporating the components into any equipments in the field such as aerospace, aviation, nuclear control, submarine, transportation, (automotive driving and control, passenger protection, train control, ship control), transportation signal, disaster prevention, medical, public information network etc.

where higher safety and reliability are especially required, please contact Taiyo Yuden Co., Ltd. for more detail in advance.

And before incorporating the components or devices into the equipments not mentioned in the above, if there is possibility of direct damage or injury to human body, please contact Taiyo Yuden Co., Ltd. for more detail in advance.